

TECHNICAL SPECIFICATION SHEET

400 WATT, HPS S51 CWA
BALLAST E-971-XX-SO400 60Hz

CAPACITOR

RATING 55 MFD±3%
240 VAC, MIN

Dry Film Capacitors
Thermal Plastic Case

Dry film capacitor contains no oil; are furnished with 12" leads and includes discharge resistor.

Max. case temp. 110°C

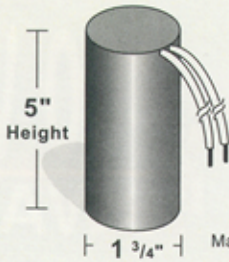

IGNITOR

37-63-AS-6.9 N6
(Thermal Plastic Case)

2 F.T. MAX
Distance to lamp.

Max. case temp. 110°C

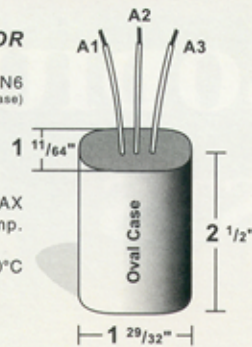

CORE AND COIL

(4 1/4" X 4 3/4" CORE)

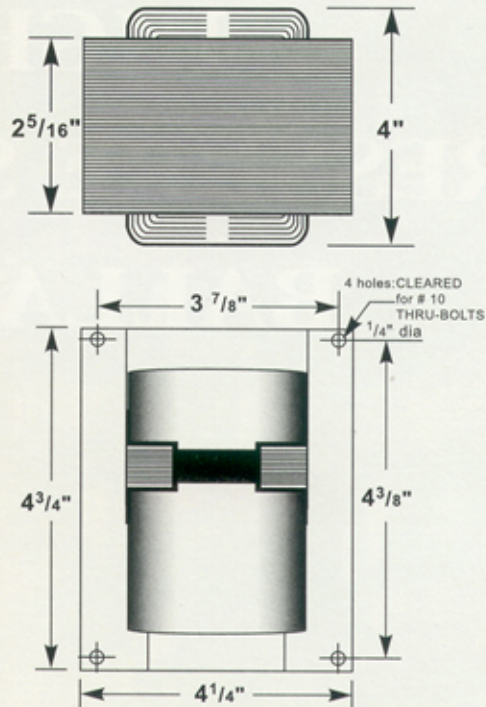

SOLA ballast leads wires are properly identified indicating on their surfaces the input voltages. ALL LEAD LENGTHS: 12 INCHES

BRACKET

CORE & COIL
MOUNTING BRACKET

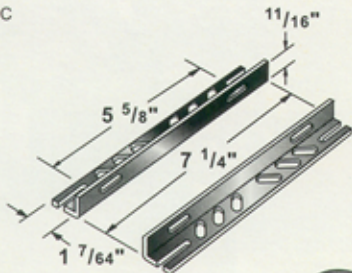

KB47
Mounting bracket for
Core & Coil Ballasts
(2 brackets with thru bolts)



C-01



I-01

MOUNTING CLIP for round case (Furnished as standard with B suffix ballasts)

MOUNTING CLIP for oval case (Furnished as standard with B suffix ballasts)

ELECTRICAL CHARACTERISTICS

INPUT VOLTAGE RANGE ±10%
POWER FACTOR HIGH
LAMP POWER REG. ±10%
MIN. STARTING TEMP. -40°C

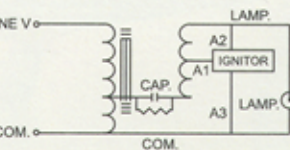

SINGLE VOLTAGE

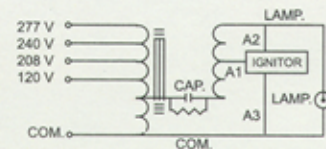

MULTI VOLTAGE
120/208/240/277
VOLT CONNECTION

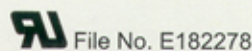

Line Voltage	Catalog Number	Circuit Type	Input Watts	Line Current (AMPS)			Open Circuit Voltage	Drop Out Voltage	Fuse	Ballast Net Weight (lbs)	UL Bench Top Rise Code 1029
				Operating	Open Circuit	Starting					
120	E-971-F-SO400	CWA	464	3.90	2.13	3.05	190	85	15	14.6	D
208	E-971-R-SO400	CWA	464	2.25	1.20	1.74	190	145	8	14.6	D
240	E-971-M-SO400	CWA	464	1.95	1.1	1.52	190	170	5	14.6	D
277	E-971-T-SO400	CWA	464	1.70	0.93	1.30	190	195	5	14.6	D
480	E-971-DD-SO400	CWA	464	1.00	0.52	0.75	190	330	5	14.6	D
120 or 208 or 240 or 277	E-971-W-SO400	CWA	464	3.90	2.13	3.05	190	85	15	14.6	D
		CWA	464	2.25	1.20	1.74	190	145	8	14.6	
		CWA	464	1.95	1.1	1.90	190	170	5	14.6	
		CWA	464	1.70	0.93	1.65	190	195	5	14.6	

ORDERING INFORMATION

***Add proper suffix to catalog number when ordering as indicated below:
No suffix= Core and Coil and Ignitor Only
B= Core and Coil, Ignitor and Bracket
C= Core and Coil, Ignitor and Capacitor
BC= Core and Coil, Ignitor, Capacitor and Bracket

Lighting Source, Inc.
6064 Jereme Trail
Dallas, TX 75252
Tel: (888) 385-4448 (972) 248-3399
Fax: (972) 248-4748
E-mail: lighting@airmail.net
Website: www.ballastsource.com

